



直得科技股份有限公司
CHIEFTEK PRECISION Co., LTD.

DR Series



DD Motor

* cpc reserves the right to revise any information (technical details) any time without notice, for printing mistakes or any other incidental mistakes. We take no responsibility.

cpc CHIEFTEK PRECISION Co., LTD.

HEADQUARTERS

CHIEFTEK PRECISION Co., Ltd.
No.3, Doli^{1st} Rd., Sinshih Township,
Tainan Science Park, 741-45 Tainan, Taiwan, R.O.C
TEL:+886-6-505 5858 Http://www.chieftek.com
E-mail:service@mail.chieftek.com

CHIEFTEK PRECISION USA
2280 E. Locust Court,
Ontario, CA 91761, USA
Tel: +1-909-428-9300
Fax: +1-909-428-7171

cpc Europa GmbH
Industriepark 314,
D-78244 Goltmadingen, Germany
TEL:+49-7731-59130-38
FAX:+49-7731-59130-28

CHIEFTEK MACHINERY KUNSHAN Co., Ltd.
No. 1188, Honggiao Rd, Kunshan,
Jiangsu, P.R. China
TEL:+86-512-5525 2831
FAX:+86-512-5525 2851



Features

Frameless type / DR series



① Highest torque density & motor constant.



② Large pass through

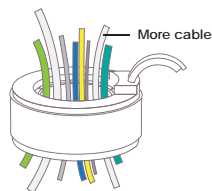

③ High heat dissipation



④ Cable output option



Ordering Information

DR	K	105	8	S	H	P	N	CS	0400	
										Cable length (mm) : 0400 : 400 mm (Standard) Rotor : Blank
										Cable exit direction : CS : Radial CU : Axial Rotor : Blank
										Cooling : N : No cooling W : Water cooling Rotor : Blank
										Temperature sensor: P : PTC-90°C K : KTY84-130 Rotor: Blank
										H : Hall sensor. NH : No hall sensor.
										Winding code : S : Standard F : Small current Rotor : Blank
										Height (mm) : 105 series 8, 16, 24, 32, 40, 48, 56, 80, 88 140 series 8, 16, 24, 30, 32, 38, 50, 58, 70, 78
										Outside diameter of the stator (mm) : 105, 140
										Part : K : Kit S : Stator R : Rotor
Torque motor										

* To support hall function, the rotor height need to be higher.

* Configuring table of Hall type.

		Unit: mm		
	Assembly height	Stator height	Rotor height	
105 series	8	8	16	
	16	16	24	
	24	24	32	
	32	32	40	
	48	48	56	
	80	80	88	

		Unit: mm		
	Assembly height	Stator height	Rotor height	
140 series	8	8	16	
	16	16	24	
	24	24	32	
	30	30	38	
	50	50	58	
	70	70	78	

Torque Overview

DR-105

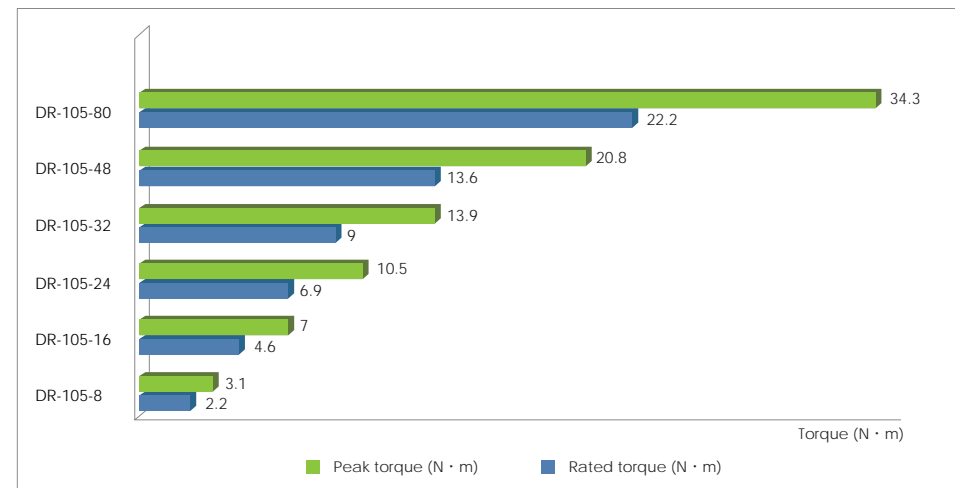

DR-140

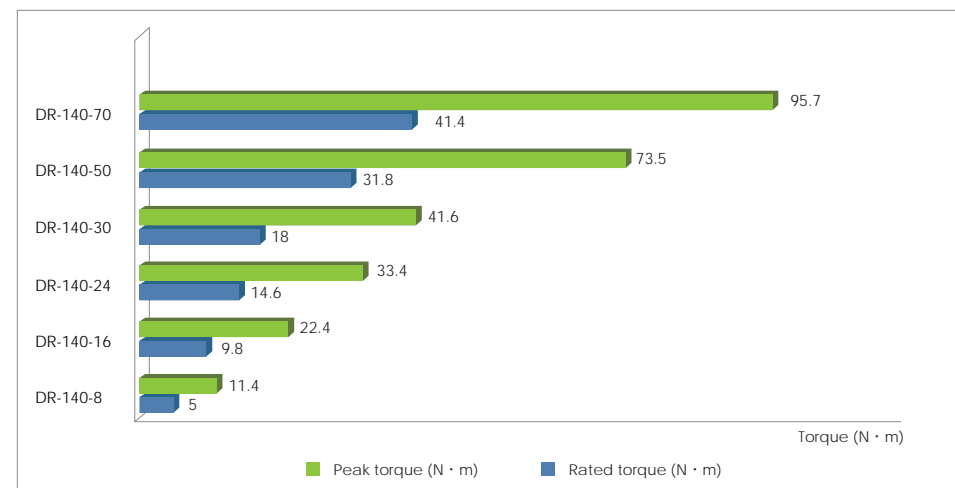



DR-105 series

DR-105

	Unit	cpc											
		3-phase synchronous frameless Torque, 230V _{ac,rms} (325V _{dc})											
Coil Assembly Model		DR-105-8		DR-105-16		DR-105-24		DR-105-32		DR-105-48		DR-105-80	
Winding code		S	F	S	F	S	F	S	F	S	F	S	F
Performance													
Peak Torque ⁽²⁾⁽³⁾	Nm	3.1	7.0	10.5	13.9	20.8	34.3						
Continuous Torque with heat sink ⁽¹⁾⁽²⁾	Nm	2.2	4.6	6.9	9.0	13.6	22.2						
Continuous Torque without heat sink ⁽²⁾⁽³⁾	Nm	1.1	2.2	3.3	4.2	6.3	10.1						
Maximum Power with heat sink ⁽¹⁾⁽²⁾	W	183.7	242.8	301.8	352.0	467.2	680.3						
Continuous Power with heat sink ⁽¹⁾⁽²⁾	W	73.3	96.2	119.6	143.1	182.5	261.7						
Continuous Power without heat sink ⁽²⁾⁽³⁾	W	18.3	25.0	31.1	34.4	45.6	62.8						
Maximum speed AC 230V@DC 325V	rpm	5130	1710	2590	858	1721	571	1288	428	861	286	516	171
Maximum speed AC 420V@DC 600V	rpm	9470	3157	4783	1584	3178	1054	2380	791	1589	527	953	316
Mechanical													
Stator OD	mm	105											
Rotor ID	mm	56											
Lamination Stack Height	mm	8	16	24	32	48	80						
Rotor Inertia	kg·m ²	5.8·10 ⁻⁵	1.2·10 ⁻⁴	1.7·10 ⁻⁴	2.3·10 ⁻⁴	3.5·10 ⁻⁴	5.8·10 ⁻⁴						
Stator Mass	kg	0.51	0.92	1.42	1.93	2.95	4.98						
Rotor Mass	kg	0.06	0.12	0.19	0.25	0.37	0.62						
Total Mass	kg	0.57	1.04	1.61	2.18	3.32	5.6						
Electrical													
Peak Current ⁽²⁾⁽³⁾	A _{pk}	8.1	2.7	8.1	2.7	8.1	2.7	8.0	2.6	8.0	2.6	7.9	2.5
Continuous Current with heat sink ⁽¹⁾⁽²⁾	A _{pk}	5.1	1.7	5.1	1.7	5.1	1.7	5.1	1.6	5.0	1.6	4.9	1.5
Continuous Current without heat sink ⁽²⁾⁽³⁾	A _{pk}	2.6	0.8	2.6	0.8	2.6	0.8	2.5	0.7	2.5	0.7	2.4	0.6
Max. current (Linear range) ⁽²⁾	A _{pk}	5.5	1.9	5.5	1.9	5.5	1.9	5.5	1.9	5.4	1.8	5.4	1.8
Motor Torque constant	Nm/A _{pk}	0.43	1.30	0.86	2.60	1.29	3.90	1.72	5.20	2.58	7.81	4.30	13.01
Back EMF constant ⁽²⁾	V/rad/s	0.50	1.50	0.99	2.99	1.49	4.49	1.99	5.99	2.98	8.98	4.97	14.97
Resistance	Ω	2.8	24.8	3.7	32.2	4.6	39.6	5.5	47	7.3	61.8	10.9	91.4
Inductance	mH	16.50	132.50	29.20	229.30	41.90	326.10	54.60	422.90	80.00	616.50	130.80	1003.7
Time constant ⁽²⁾	ms	5.9	5.3	7.9	7.1	9.1	8.2	9.9	9.0	11.0	10.0	12.0	11.0
Thermal Resistance without heat sink ⁽²⁾⁽³⁾	°C/W	1.19		0.83		0.67		0.59		0.44		0.31	
Thermal Resistance with heat sink ⁽¹⁾⁽²⁾	°C/W	4.80		3.66		2.96		2.72		2.07		1.50	
Motor Constant ⁽²⁾	N/W	0.26		0.45		0.60		0.73		0.95		1.30	
Magnet poles	(N 2τ)	20											
Ph-PE dielectric strength		≥ 1.5KV(AC)											
Ph-PE insulation Resistance		≥ 600V(DC)											

(1) This value applies to the static sinusoidal drive under specific heat sink and temperature ranges from 25°C up to 110°C. The actual performance is dependent on the heat sink configuration, system cooling condition and ambient temperature.
 (2) The tolerance levels for the total performance and electrical specification is ±10%
 (3) This value applies to static sinusoidal drive operating under temperatures from 25°C up to 110°C, without a heat sink.
 (4) The above "without heat sink" figure assumes a working condition of 1 atm, 25°C ambient temperature, in which the linear motor is stationary and not in contact with any other objects, relying only on free air convection for cooling. As all heat conductive objects in direct contact with the motor, including the plate, bearing and housing, can be considered a kind of heat sink, the "with heat sink" figure should be taken as the primary reference in actual application design.

Torque / Speed Curve (AC 230V@DC 325V) (AC 420V@DC 600V)

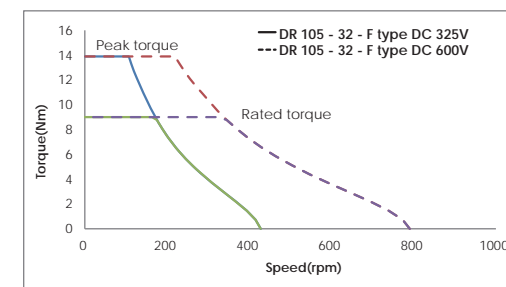
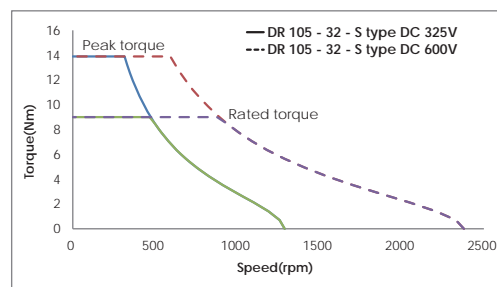
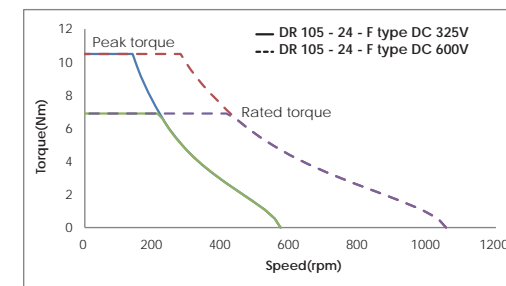
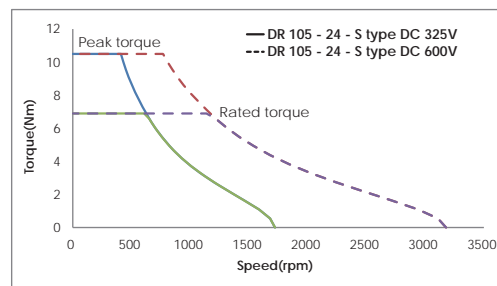
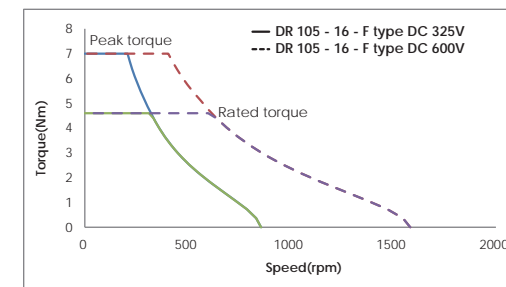
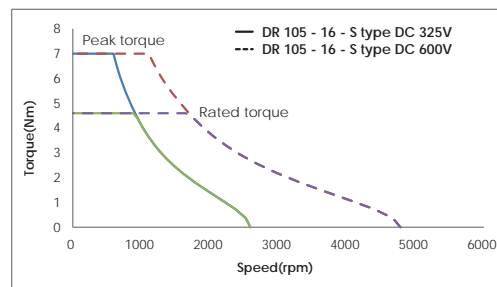
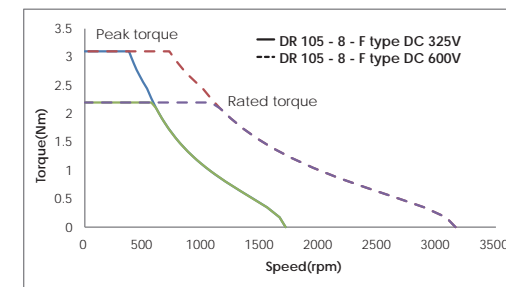
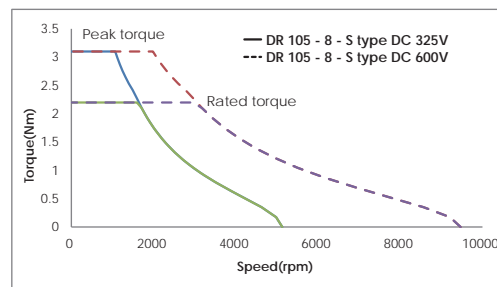

Torque / Speed Curve (AC 230V@DC 325V) (AC 420V@DC 600V)

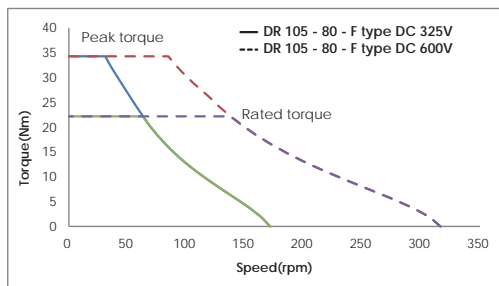
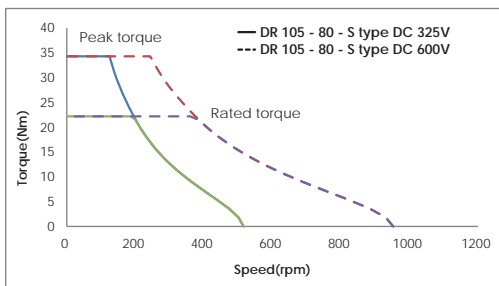
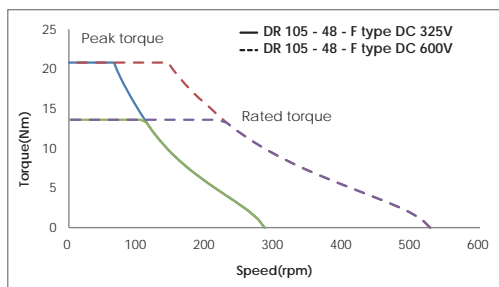
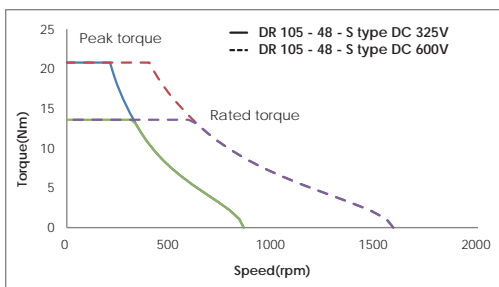

DR-140 series

DR-140

		cpc											
		3-phase synchronous frameless Torque 230V _{ac} /mm (325V _{dc})											
Coil Assembly Model		DR-140-8		DR-140-16		DR-140-24		DR-140-30		DR-140-50		DR-140-70	
Winding code		S	F	S	F	S	F	S	F	S	F	S	F
Performance													
Peak Torque ⁽¹⁾⁽²⁾	Nm	11.4	22.4	33.4	41.6	73.5	95.7						
Continuous Torque with heat sink ⁽¹⁾⁽²⁾	Nm	5.0	9.8	14.6	18.0	31.8	41.1						
Continuous Torque without heat sink ⁽²⁾⁽³⁾	Nm	3.0	6.0	8.9	10.8	19.1	24.4						
Maximum Power with heat sink ⁽¹⁾⁽²⁾	W	1555.4	1952.3	2342.7	2616.4	3588.0	4487.5						
Continuous Power with heat sink ⁽¹⁾⁽²⁾	W	90.4	113.5	136.2	148.3	203.4	249.9						
Continuous Power without heat sink ⁽²⁾⁽³⁾	W	33.3	41.8	50.1	53.4	73.2	88.0						
Maximum speed AC 230V@DC 325V	rpm	10000	2617	6576	1329	4422	890	3562	712	2019	402	1535	306
Maximum speed AC 420V@DC 600V	rpm	10000	4831	10000	2453	8164	1644	6576	1315	3728	743	2835	566
Mechanical													
Stator OD	mm	140											
Rotor ID	mm	60											
Lamination Stack Height	mm	8	16	24	30	50	70						
Rotor Inertia	kg·m ²	3.99*10 ⁻⁴	7.55*10 ⁻⁴	1.11*10 ⁻³	1.38*10 ⁻³	2.27*10 ⁻³	3.2*10 ⁻³						
Stator Mass	kg	0.56	1.11	1.67	2.09	3.48	4.87						
Rotor Mass	kg	0.26	0.5	0.69	0.89	1.46	2.04						
Total Mass	kg	0.82	1.61	2.36	2.98	4.94	6.91						
Electrical													
Peak Current ⁽²⁾⁽³⁾	A _{pk}	126.0	25.3	126.0	25.3	126.0	25.3	126.0	25.2	126.0	25.2	125.0	25.0
Continuous Current with heat sink ⁽¹⁾⁽²⁾	A _{pk}	30.0	6.1	30.0	6.1	30.0	6.1	30.0	6.0	30.0	6.0	29.8	5.9
Continuous Current without heat sink ⁽²⁾⁽³⁾	A _{pk}	18.0	3.7	18.0	3.7	18.0	3.7	18.0	3.6	18.0	3.6	17.8	3.5
Max. current (Linear range) ⁽²⁾	A _{pk}	30.0	6.1	30.0	6.1	30.0	6.1	30.0	6.0	30.0	6.0	29.8	5.9
Motor Torque constant	Nm/A _{pk}	0.16	0.82	0.32	1.61	0.48	2.40	0.60	3.00	1.06	5.30	1.39	6.96
Back EMF constant ⁽²⁾	V/rad/s	0.20	0.98	0.39	1.93	0.58	2.88	0.72	3.60	1.27	6.37	1.67	8.36
Resistance	Ω	0.10	2.43	0.12	3.05	0.15	3.66	0.16	4.12	0.23	5.65	0.29	7.18
Inductance	mH	0.43	10.75	0.86	21.50	1.29	32.20	1.62	40.40	2.70	67.50	3.74	93.50
Time constant ⁽²⁾	ms	4.4		7.0		8.8		9.8		11.9		13.0	
Thermal Resistance without heat sink ⁽²⁾⁽³⁾	°C/W	0.94		0.75		0.62		0.57		0.42		0.34	
Thermal Resistance with heat sink ⁽¹⁾⁽²⁾	°C/W	2.56		2.04		1.70		1.59		1.16		0.97	
Motor Constant ⁽²⁾	N/√W	0.52		0.92		1.25		1.48		2.23		2.60	
Magnet poles	N(2τ)	20											
Ph-PE dielectric strength		≥1.5KV(AC)											
Ph-PE insulation Resistance		≥600V(DC)											

Dimension

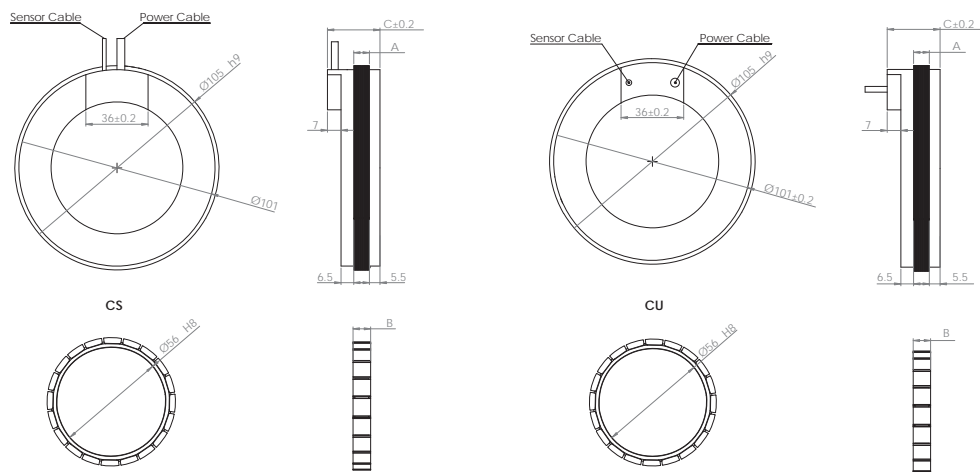

OUTPUT CABLE (All cable standard length is 400 mm)

Motor Wire Table				Hall Sensor Wire Table and Thermal Protection Wire Table				
Pin Number	Function	Cross section	Color	Function	Cable Dia.	Color	Function	Cable Dia.
	U phase	0.5 mm ²	Pink	Hall A U phase	0.14 mm ²	Brown	Thermal sensor	0.14 mm ²
	V phase	0.5 mm ²	Yellow	Hall B V phase	0.14 mm ²	Blue		
	W phase	0.5 mm ²	Green	Hall C W phase	0.14 mm ²		Shielding	
	PE + shielding	0.5 mm ²	Grey	Hall IC + 5V	0.14 mm ²			
			White	GND	0.14 mm ²			

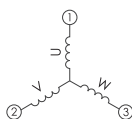

DIMENSIONS

type	A	B	C
DR-105-8	8	9	27
DR-105-16	16	17	35
DR-105-24	24	25	43
DR-105-34	32	33	51
DR-105-48	48	49	67
DR-105-80	80	81	99

(1) This value applies to the static sinusoidal drive under specific heat sink and temperature ranges from 25°C up to 110°C. The actual performance is dependent on the heat sink configuration, system cooling condition and ambient temperature.
 (2) The tolerance levels for the total performance and electrical specification is ±10%
 (3) This value applies to static sinusoidal drive operating under temperatures from 25°C up to 110°C, without a heat sink.
 (4) The above "without heat sink" figure assumes a working condition of 1 atm, 25°C ambient temperature, in which the linear motor is stationary and not in contact with any other objects, relying only on free air convection for cooling. As all heat conductive objects in direct contact with the motor, including the plate, bearing and housing, can be considered a kind of heat sink, the "with heat sink" figure should be taken as the primary reference in actual application design.

Torque / Speed Curve (AC 230V@DC 325V) (AC 420V@DC 600V)

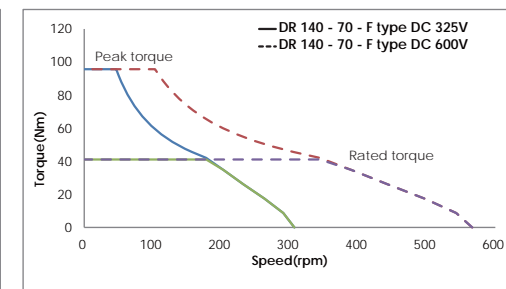
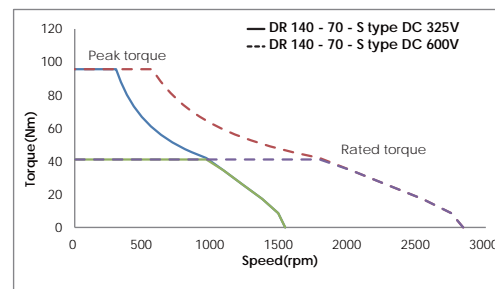
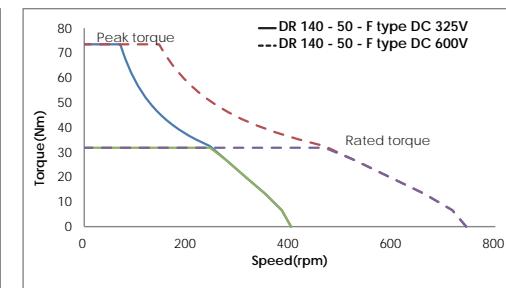
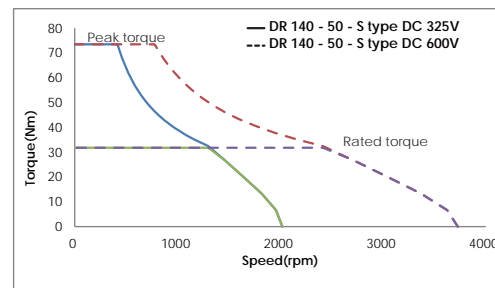
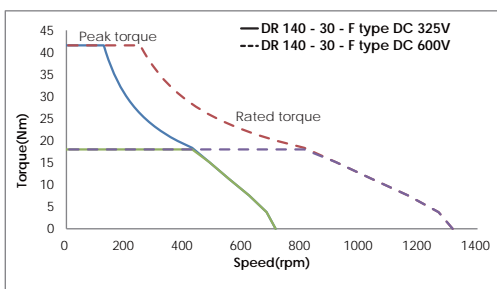
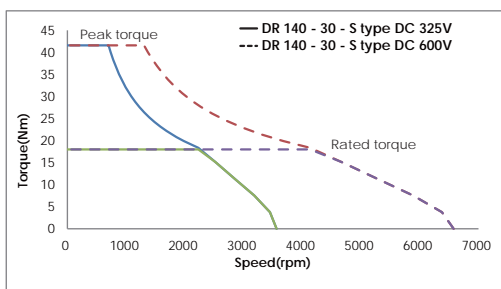
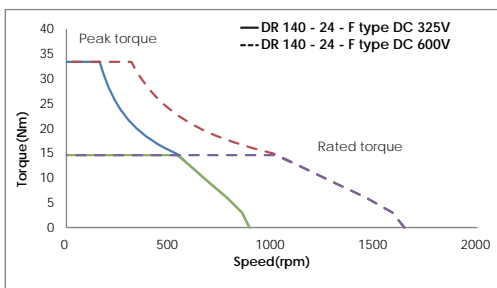
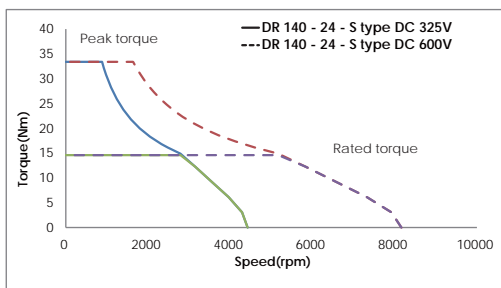
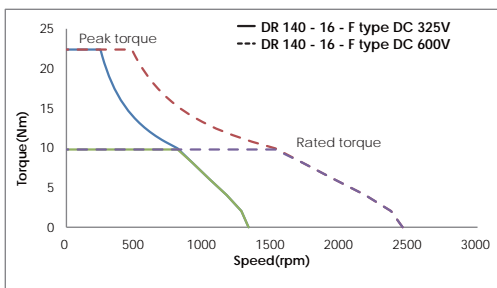
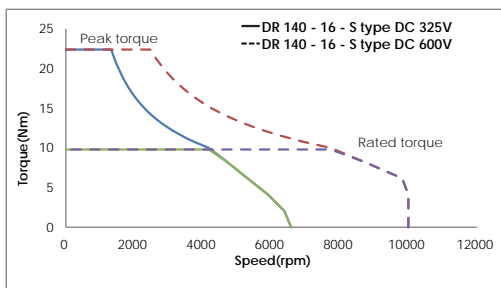
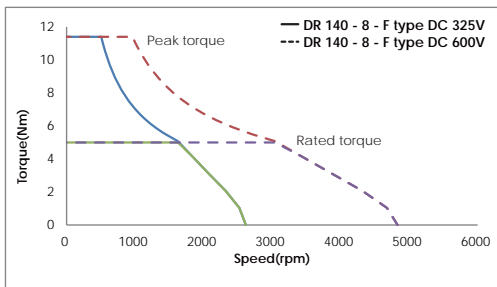
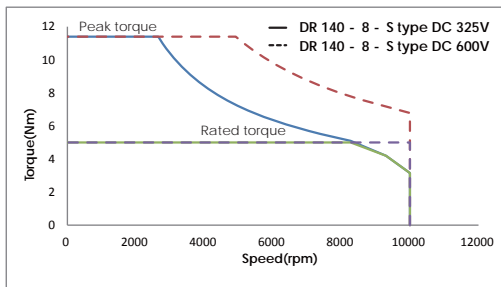

Dimension

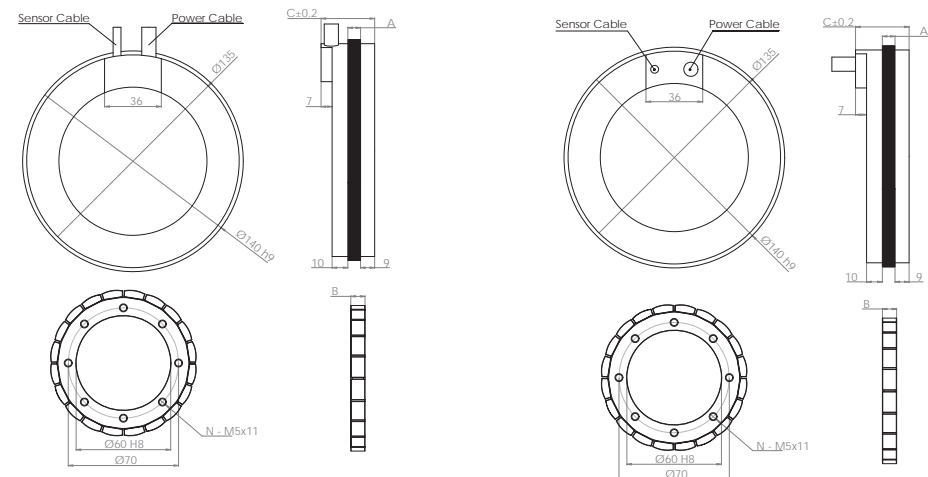

OUTPUT CABLE (All cable standard length is 400 mm)

Motor Wire Table				Hall Sensor Wire Table and Thermal Protection Wire Table				
Pin Number	Function	Cross section	Color	Function	Cable Dia.	Color	Function	Cable Dia.
White	U phase	1.5 mm ²	Pink	Hall A U phase	0.14 mm ²	Brown	Thermal sensor	0.14 mm ²
Yellow	V phase	1.5 mm ²	Yellow	Hall B V phase	0.14 mm ²	Blue	Shielding	
Brown	W phase	1.5 mm ²	Green	Hall C W phase	0.14 mm ²			
Green	PE + shielding	1.5 mm ²	Grey	Hall IC + 5V	0.14 mm ²			
			White	GND	0.14 mm ²			

DIMENSIONS

Type	N	A	B	C
DR-140-08	8	8.05	9	34
DR-140-16		16.1	17	42
DR-140-24		24.15	25	50
DR-140-30		30.1	31	56
DR-140-50		50.05	51	76
DR-140-70		70	71	96